



ING. O. FIORENTINI S.R.L.
INDUSTRIAL CLEANING MACHINES

SCRUBBER
- MOD. I42TD - I60TD -



USER MANUAL

Congratulations for your choice!

***FIorentini S.r.l.** thanking you for the preference to its product, would like to remind you that **FIorentini S.r.l** production covers manufacture and marketing of industrial cleaning machines and is a leading company in this sector.*

***FIorentini** tradition and competence guarantee the technical quality of your choice. Its products are built with first quality materials and are therefore reliable, solid and functional in order to satisfy all customers. **FIorentini** has recently obtained the quality system certificate conforming to the requirements of **UNI EN ISO 9001:2000**.*



We wish therefore inviting you to contact us for every kind of request, as technical or commercial. We will be at your disposal for any information you may need.

INDEX

1. GENERAL INFORMATION
2. SYMBOLS
3. PREMISES
 - 3.1 MANUAL CONSULTING
 - 3.2 WARRANTY
 - 3.2.1 WARRANTY OBJECT
 - 3.2.2 WARRANTY LIFE
 - 3.2.3 WARRANTY APPLICATION
 - 3.2.4 RETURNED GOODS
 - 3.2.5 EXCEPTIONS
 - 3.3 CONFORMITY DECLARATION
4. MACHINE FEATURES AND TECHNICAL DATA
 - 4.1 IDENTIFYING THE MACHINE
 - 4.2 DESCRIPTION AND FEATURES OF THE MAIN PARTS
 - 4.2.1 DESCRIPTION
 - 4.2.2 MAIN PARTS OF THE MACHINE
 - 4.3 TECHNICAL DATA
 - 4.3.1 DASHBOARD
 - 4.3.2 MACHINE USE
5. SAFETY
 - 5.1 RIGHT USE OF THE MACHINE
 - 5.2 WRONG USE OF THE MACHINE
 - 5.3 SUGGESTED EQUIPMENTS
 - 5.4 OPERATOR'S QUALIFY
 - 5.5 SAFETY AND WARNING DEVICES
 - 5.6 OTHER DANGERS
 - 5.7 SAFETY SIGNALS
6. STARTING THE MACHINE
 - 6.1 TRANSPORT AND HANDLING
 - 6.2 STORAGE
 - 6.3 STARTING THE MACHINE
7. MAINTENANCE
 - 7.1 PERIODICAL MAINTENANCE
 - 7.2 SUCTION MOTORS MAINTENANCE
 - 7.3 DIESEL MOTOR MAINTENANCE
 - 7.4 ELECTRIC SYSTEM CHECK UP
 - 7.5 MAINTENANCE REGISTER
8. SERVICE
 - 8.1 SERVICE ADDRESSES
 - 8.2 CLAIM REPORT

1. GENERAL INFORMATION

2. SYMBOLS

	<i>This symbol is used to get the operator's attention on procedures or precautions to be followed in order to avoid damages to users or to the support</i>
	<i>This symbol is used to get the operator's attention on general information.</i>

3. PREMISE



FIorentini S. r. l. is the only owner of this manual.

The reproduction of all or part of the manual or the transmission to third parties with mechanic or electronic devices are forbidden without a written manufacturer's authorization. This manual is supplied to the customers in one original copy when differently specified during the order.

This manual is supplied to the customer with the machine and it must be kept with it even when the machine has to be transferred.

Please, keep the manual in a safe place and for all the machine lifetime. Purchaser is responsible for showing the manual to qualified people. In case of loss ask for a duplicate to FIORENTINI Co..

FIORENTINI S.r.l. is not responsible for any kind of damages caused by people or things due to the non-observance of the instructions of this manual.

FIORENTINI reserves the right to add at any time and without notice all the technical and commercial changes considered useful for the customer. Therefore data and information in this manual can be updated.

3.1. MANUAL CONSULTING

This manual deals exhaustively with all arguments that are necessary for an easy and safe use of the machine as it is recommended by European Directives on product safety.

Therefore we suggest to all authorized operators to read carefully this manual contacting FIORENTINI S.r.l. for any explanation. The manual has to be used every time the operator forgets a procedure or when new operators have to be trained.

For publishing reasons, pictures and drawings can look different from the reality but without arising doubts.

Special symbols and **bold type** and/or *sloping* get the attention of the reader on remarkable information in particular for safety.

The revision index is written on the left at the bottom of every page. The list of those pages that have been updated has to be found at the end of the manual.

3.2. WARRANTY

Warranty conditions are stated as below when not differently specified in the order confirmation.

3.2.1. WARRANTY OBJECT

The machine has been designed and built for a long-lasting use without relevant problems. Anyway, if problems arise during the warranty period, FIORENTINI S.r.l. is engaged to repair or substitute for free those parts that are broken or damaged by defective materials, working defects or imperfect assembly.

Warranty is not given for parts whose early breaking or wear and tear are due to:

Non-respect of instructions included in this manual;

- Breaking and/or changes made up without FIORENTINI's approval;
- Not-use of genuine spare parts;
- Interventions made up by unauthorized personnel;
- Missing maintenance;
- Natural calamities.

FIORENTINI S.r.l., its purchasers and its suppliers have the same warranty for the electric and expendable materials that are sold by external suppliers.

3.2.2. WARRANTY LIFE

The warranty is granted for 24 months since the machine delivery date. This is a single warranty term and it cannot be extended.

3.2.3. APPLICATION MODALITY

Defective components must be sent back to FIORENTINI S.r.l. in order to establish the causes of the anomalies and apply therefore the warranty. Repair and replacement under warranty will be done in FIORENTINI's workshop, by third parties or in loco. In case of repair or replacement in loco, energy sources and the use of particular equipment have to be paid by the customer himself.

3.2.4. RETURNED GOODS

Intervention demands must be sent to FIORENTINI Service Dept. only after a careful analysis of the problem and its causes. Following information have to be given to FIORENTINI's agent:

- Serial number you get it from the silver label stucked on the machine (§ 2.1.);
- Code and position of the component taken from the spare parts list (§ 7.2.);
- A detailed description of the problem and its causes.

The components considered under warranty are delivered ex works; those ones being substituted belong to FIORENTINI Co..

3.2.5. EXCEPTIONS

Expandable materials like brushes, squeegee blades and materials whose lifetime cannot be predetermined are not under warranty.



The machine warranty is no more available in case of the loss of the silver label.

1.5. CONFORMITY DECLARATION

The conformity declaration is released with the machine and the user manual.

DICHIARAZIONE-DECLARATION-DECLARATION-ERKLÄRUNG- DECLARACION

DICHIARAZIONE CE DI CONFORMITÀ
DECLARATION OF CONFORMITY
DECLARATION DE CONFORMITE
ÜBEREINSTIMMUNGSERKLÄRUNG
DECLARACION DE CONFORMIDAD

ING. O. FIORENTINI s.r.l.
Loc. Rombola
50030 PIANCALDOLI (FI) ITALIA

Dichiara sotto la propria esclusiva responsabilità che la macchina:
Declares under its own responsibility that the machine :
Déclare sous sa responsabilité exclusivement que la machine :
erklärt unter ausschließlich eigener Verantwortung, daß die Maschine :
declara bajo su propia y exclusiva responsabilidad que la máquina :

FIORENTINI

Modello/model/modele/modell/modelo
Matricola/serial number/numero
matricule/serienummer/numero matricula
Anno/year/année/jahr/ano

2010



Fabbricata nel rispetto delle direttive e decreti :
and moreover is built according to the directives and decrees :
et est fabriquées à, en outre, conformément aux directives et ou décrets :
und daß sie unter Einhaltung folgender Verordnungen und/oder Dekrete hergestellt worden (sind) :
y que además ha sido fabricada en conformidad con las directivas y/o decretos :

2006/42/CE/EC/EG-

Direttiva macchina: Machines Directive: Maschinen Richtlinie: Directive machines:

2004/108/CE/EC/EG-

Compatibilità elettromagnetica: Electro Magnetic Compatibility: Elektromagnetische Verträglichkeit: Compatibilité électromagnétique:

2002/95/CE/EC/EG-

Restrizione sostanze pericolose: Restrictions of Dangerous Substances Beschränkung der gefährlichen Mitteln :Restriction des substances dangereuses

2003/10/CE/EC/EG

Protezione da rumore: Exposure of Workers to Noise: Gefährdung der Arbeitnehmer durch Geräusch: Exposition des travailleurs aux Bruits:

È conforme alle seguenti norme :
conform to the following laws :
est conforme aux norms :
mit den folgenden Normen übereinstimmen :
está conforme a lassiguientes normas :

EN 12100-1- EN 12100-2

Norme applicate: Harmonized Standard Applied: Angewandte harmonisierte Normen: Normes Harmonisées Appliquées :

Ing. O. Fiorentini S.r.l.

Il titolare/chairmen/gérant

Ing. O. Fiorentini

Piancaldoli

Luogo e data

Firma

O. Fiorentini

In caso di modifiche apportate alla macchina questa dichiarazione non è più valida

4. MACHINE FEATURES AND TECHNICAL DATA

4.1. IDENTIFYING THE MACHINE

A silver label is stuck on the protection case of the steering column and clearly shows the data referring to the “CE” marking.



PICTURE N° 2.1



The label has never to be removed and should always be kept readable. In case of damage it is necessary to ask for a duplicate. The autoscrubber machine cannot be sold without the label.

4.2. DESCRIPTION AND COMPONENTS

The scrubbing machine – Mod. I42TD - has been designed to clean all flat surfaces by means of washing and suction of the washing water.

The electric traction system is supplied by a series of batteries which supply energy to the brushes motors, to the squeegee motor and to the suction motor.

The machine is equipped with two rotating brushes which wash the surface by means of water and detergent. Whilst the machine is running forward, the back brush (squeegee) picks the water up that is directly sucked into the recovery tank.

The accelerator pedal starts both the washing brushes and the suction motor which stop automatically after a few seconds when you leave the pedal. When the washing brushes standstill, they are non more in contact with the ground. In this way the bristles will not be damaged while the brushes are not working.

Thanks to the dashboard the operator can control all the machine functions and a series of LEDs shows to the operator the battery status or the errors detected by the electronic card.

The operator can control all the main machine functions and in particular:

- Start the washing brushes;
- Regulate the quantity of water;
- Start the suction motor;
- Start the lift or the sink of the squeegee;
- Choose the forward or back gear;
- Start or stop the machine.

The machine frame is made of zinc-plated or stainless steel in order to avoid oxidation which could compromise the machine reliability.

4.2.2. MAIN PARTS OF THE MACHINE:

- Zinc-plated steel or stainless steel frame;
- ABS plastic solution tank;
- ABS plastic recovery tank supplied with flexible suction and drainage piping system;
- kubota diesel motor;
- Right rotating brush;
- Left rotating brush;
- Squeegee (suction system);
- Water recovery system;
- one driving wheel;
- two idle wheels;
- steering wheel;
- driving seat.

FIORENTINI Co., taking the new CE safety rules into consideration, manufactures the machine following the CE directives about safety and health. The materials high quality, the high technology and FIORENTINI's experience guarantee the performance and the reliability of this machine .
Each machine is tested during the manufacturing process and the final check is done before the machine is shipped out.

2.3. TECHNICAL DATA

CHARACTERISTICS	I42TD	I60TD
Dimensions		
Brushes case width	1250 mm.	1690 mm.
Height	1300 mm.	1300 mm.
Washing brushes	3	3
Traction	hydraulic	Hydraulic
Washing brushes dimension	Ø 400 mm.	Ø 480 mm.
Cleaned area	1110 mm.	1400 mm.
Squeegee width	1350 mm.	1650 mm.
Polyethylene solution tank	320 lt.	320 lt.
Polyethylene recovery tank	330 lt.	330 lt.
Petrol tank	18 lt.	18 lt.
Hydraulic oil tank	15 lt.	15 lt.
Front wheel diameter	300 mm.	300 mm.
Rear wheel diameter	300 mm.	300 mm.
Sucked air volume	90 l/s	90 l/s
Brushes pressure	150 kg.	150 kg.
Kerb weight without operator	750 kg.	750 kg.
Motors		
Motor	diesel	Diesel
Cylinders	3	3
Displacement	719 cc	719 cc
Power	16 Kw – 360 rpm	16 Kw – 360 rpm
Brushes hydraulic motor	OMR 80	OMR 80
Traction hydraulic motor	OMP 160	OMP 160
Variable displacement pump	APV 14/9	APV 14/9
Fixed displacement pump	MLPD BCG 144 FM	MLPD BCG 144 FM
Suction motors	2x800W 13A 16000 rpm	2x800W 13A 16000 rpm
Functions		
Drive	Man on board	Man on board
Minimum corridor for an u-turn	2600 mm.	3000 mm.
Brushes up	hydraulic	Hydraulic
Squeegee up	hydraulic	Hydraulic
Service brake	Mechanical by means of a lever	Mechanical by means of a lever
Parking brake	Mechanical by means of a lever	Mechanical by means of a lever
Performances		
Forward speed	0 ÷ 12 km/h	0 ÷ 12 km/h
Backward speed	0 ÷ 12 km/h	0 ÷ 12 km/h
Maximum overwhelming slope	12%	12%
Maximum slope for a u-turn	2% at 2 km/h	5% at 2 km/h
Cleaned area m ² /h	8500	11500
Noise	73 dBA	73 dBA



The above mentioned characteristics are not binding for the manufacturer; they can be changed without any notice . ING.O.FIORENTINI Co. is always at disposal for any information (par.7.1.).

MEASUREMENT UNITS CONVERSION			
Lenght	1 inch = 1" = 25,4 mm	Power	1 kW = 1,36 CV = 1,34 BHP
Temperature	$T (K) = t (°C) + 273$ / $t (°F) = 1,8 t (°C) + 32$	Pressure	1 bar = 100 kPa = 14,5 psi

4.3.1. DASHBOARD

The dashboard is made of a series of switches that activate or disactivate all the machine functions. The function of each switch is shown by a picture. Picture 4.6. shows the dashboard of the machine and the switches function is explained in the scheme below.

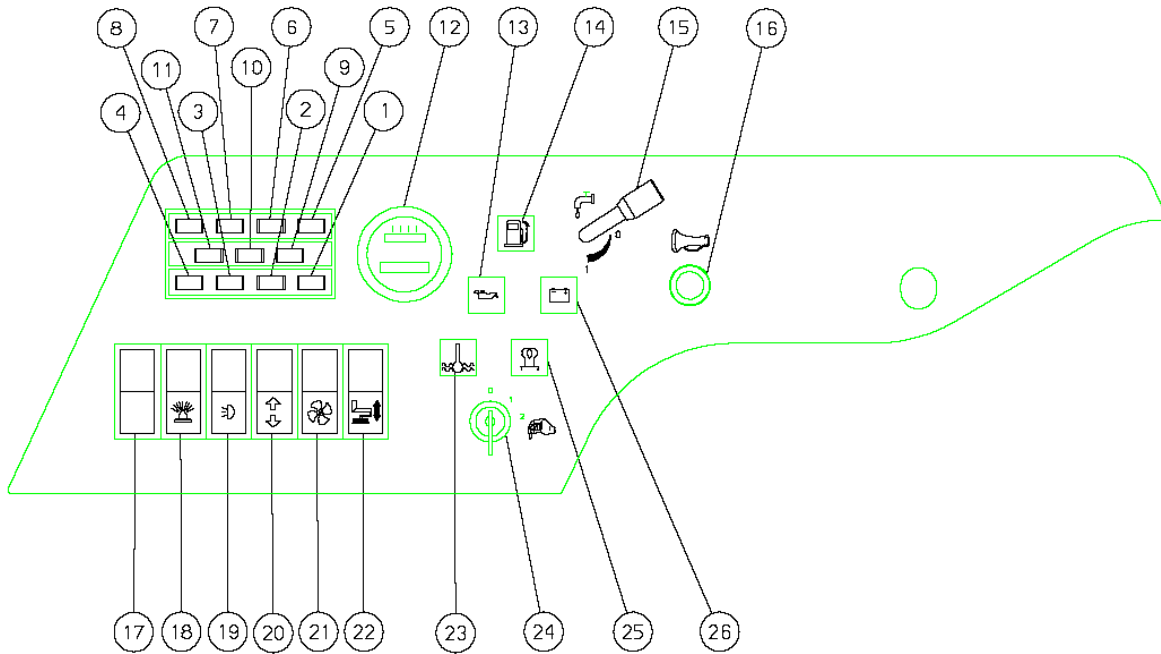





Picture no. 2

1	Flashing light fuse	14	Petrol level pilot light
2	Lights fuse	15	Solution regulation lever
3	Oil cooling fan fuse	16	Horn button
4	Solenoid valves main fuse	17	Sweeping assy (accessori)
5	Feed fuse	18	Flashing light switch
6	Direction indicator and stop fuse	19	Lights switch
7	Empty	20	Squeegee up/down
8	Empty	21	Suction motors switch
9	Empty	22	Brushes on/off-up/down
10	Empty	23	Diesel engine temperature switch
11	Empty	24	Key switch
12	Timer manometer	25	Glow plugs pilot light
13	Oil pressure pilot light	26	Battery charger pilot light

4.3.2. USE OF THE MACHINE

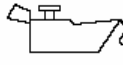
Starting the machine



OFF	Machine off
ON	Dashboard on
	Preignition glow plugs
	Battery charger
	Oil pressure
	Motor temperature pilot light

Insert the key into the dashboard and turn it (ON position). Turn the key and start the engine only when the glow plugs pilot light (no. 25 in picture 2) is switched off.

	Check the oil level into the tank of the hydraulic gearbox before using the scrubbing machine. It must be between the two notches of the level indicator.
---	--

	Important: both the battery and the motor oil pressure pilot lights must be off after the machine has been started. Otherwise read § 'Diesel Engine Maintenance'.
---	--

Detergent regulation.

	<p>Gradual increase through the rotation of the device</p>
	<p>Water valve</p>

The detergent quantity can be regulated by means of valve no. 15:

- valve clockwise turning: the detergent quantity increase while washing;
- valve counterclockwise turning: the valve closes.

Starting the machine.

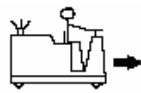
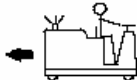
	<p>Forward gear</p>
	<p>Backward gear</p>

By means of the gas pedal the machine can move forward or backward (see pictures on both pedal's sides).



Gas pedal

Picture no. 3

Make sure that the motor rpm is the right one when starting the washing step. The rpm motor is regulated by means of the lever on dashboard side (see picture no. 4).

*Motor rpm
regulation lever*



Picture no. 4

Stop the machine.

The machine is equipped with a service brake and a parking brake. The service brake (picture no. 5) is activated by a pedal placed on the left side of the footboard. The parking brake (picture no. 6) is activated by a lever similar to a one of a car and is placed in front of the brake pedal.

*Service brake
pedal*



Picture no. 5

Parking brake

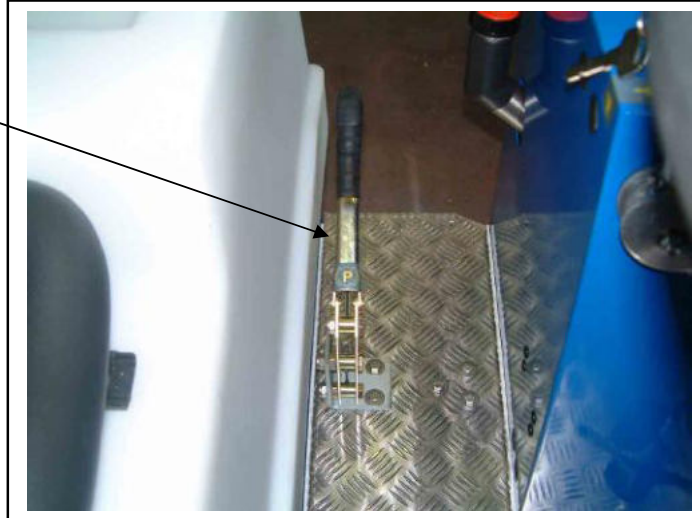

Picture no. 6



Important : check and adjust the brake at least once every three months.

Driving seat regulation.







By means of the lever under the seat (picture no. 7) the operator can regulate the distance of the seat from the steering wheel.

Regulation lever

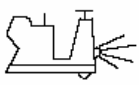

Picture no. 7

Modalità d'uso della macchina.

	Washing brush up
	Washing brush down
	Squeegee down
	Squeegee up
	Squeegee suction
	Lights
	Flashing light

The operator, thanks to his/her experience, has to choose the right kind of brush and detergent for the surfaces that has to be washed and to decide if the floor needs a second washing. Follow these instructions for a correct washing:

1. press the brushes motor switch;
2. press the solution solenoid valve switch;
3. press the suction switch.

By means of the accelerator pedal the washing brushes and the suction motor are activated. On the contrary, both the washing brushes and the suction motor are deactivated after a few seconds if the operator leaves this pedal. Before the surface is completely dry, the operator must switch the solution solenoid valve off because this is not activated/disactivated by the accelerator pedal.

The operator has to do a second washing if the surface is particularly dirty:

1. wash the surface with the squeegee up and the brushes down;
2. activate the brushes;
3. press the solution solenoid valve switch;
4. leave the solution on the surface to dissolve the dirt;
5. do a second washing with brushes and squeegee down, the suction activated and the solution solenoid valve open.



Important: switch on the flashing light before starting the machine.

Solution tank filling

Open the door next to the operator's seat (picture no. 8) and pour the detergent solution into the tank.

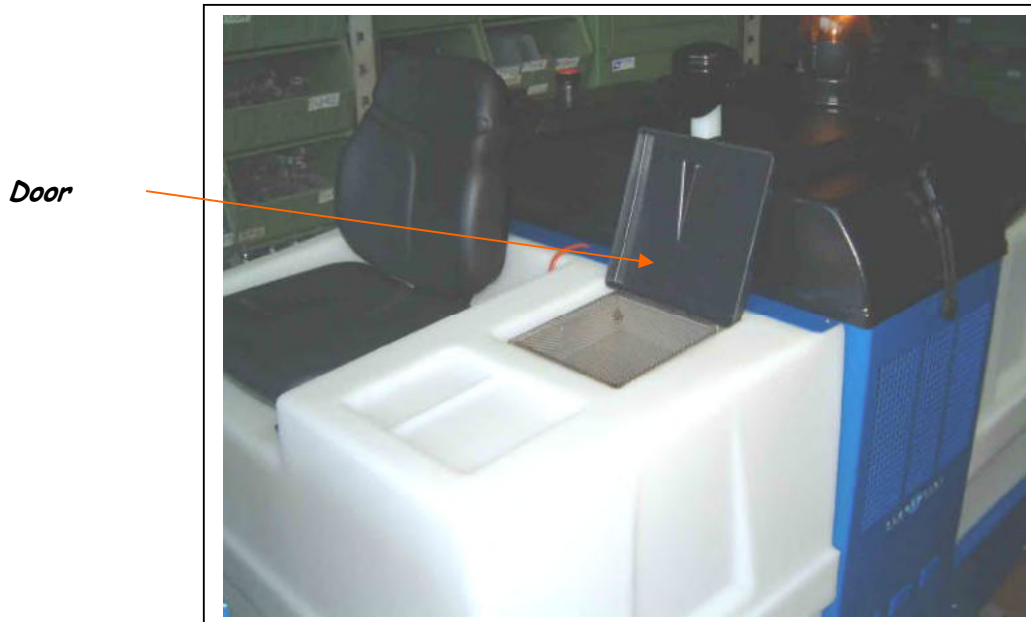

Picture no. 8



Important: do never remove the steel filter while filling the solution tank in order to avoid that foreign matters can damage the machine functioning.

Choosing the right detergent.

Choosing the right detergent is very important for a perfect cleaning. A too strong detergent could damage the surface. A good quality detergent has to produce little foam. Alternatively, the operator can add an antifoaming additive or 50 cc of wine vinaigre in the recovery tank in order to avoid the suction motor damage.



Make sure that the detergent is suitable for the dirty surface. FIORENTINI S.r.l. is not responsible for damages provoked by too aggressive detergents.

Water discharge.

The scrubber is equipped with one pipe for the water discharge (picture no. 9):

- Recovery tank water discharge (detail 1 picture 9)

If you need to discharge water from the tanks, you have to place the machine on a dump well, release the pipe of the tank and open the rubber cap at the end of the pipe itself.



Picture no. 9

Brushes replacement

Follow the instructions below for the brushes replacement (picture no. 10):

- Remove the ignition key from the dashboard in order to avoid a casual starting of the machine;
- Unscrew the knobs and remove the cover brushes case;
- Turn each brush until the operator can reach and unscrew the knob. Slightly press the knob and remove the brush;

Setting a new brush up:

- Match the female hexagon of the joint and the male join of the motor;
- Lift vertically up the brush and turn it until it will be automatically set up;
- Set up again the case and screw again the knobs.

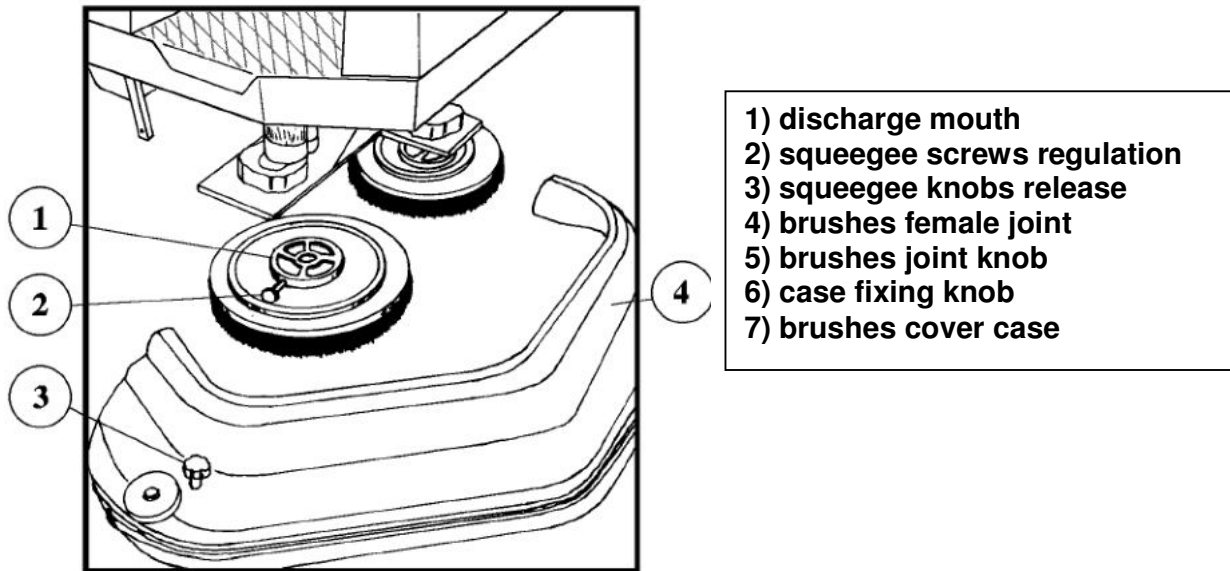

Picture no. 10

Squeegee regulation

The squeegee has to be well regulated in order to have a perfect dry system. This kind of squeegee can perfectly suck water, which flows into the suction pipe, but it must be parallel to the surface.

The operator has to follow the instructions below for the squeegee adjustment:

- Remove the ignition key from the dashboard in order to avoid the casual starting of the machine;
- unscrew the upper screws and tighten the lower ones if the blades are more pressed at the ends. Do the opposite if the blades are more pressed in the middle;
- For the pressure regulation the operator has to tighten or to widen the ring nut;
- By means of the knob (see detail nr. 2 in picture nr. 4.11.) regulate the squeegee. The best squeegee pressure is reached when the corner of its blade is in contact with the floor and their inclination is between 45° and 60°.

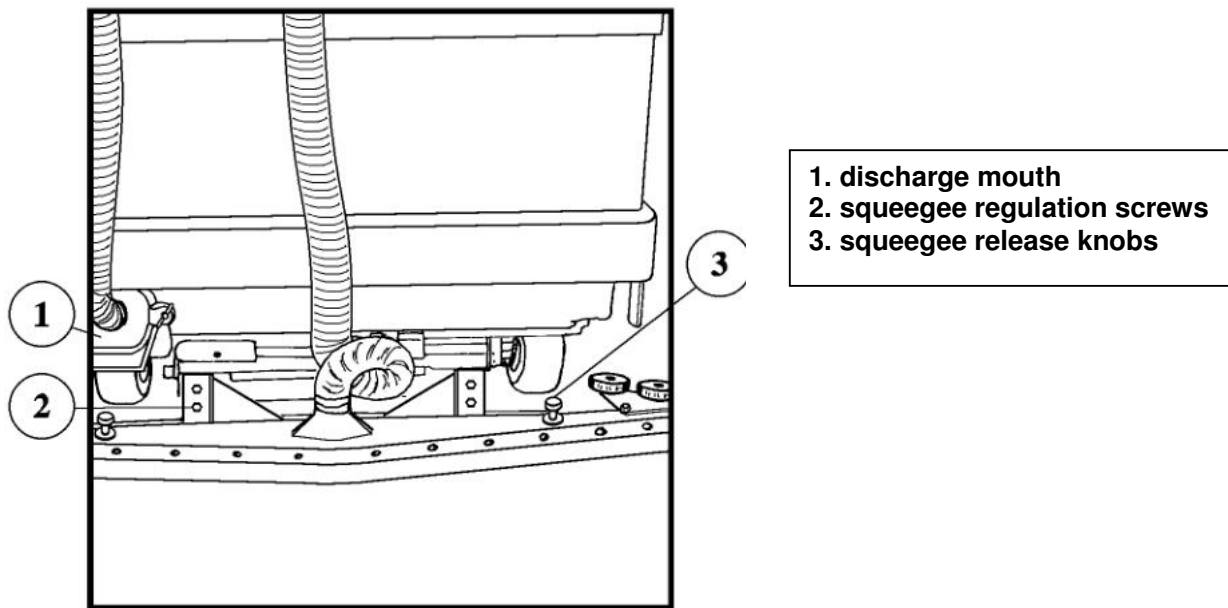

Picture no. 11

Squeegee blades replacement

Squeegee blades must be replaced when their hedges are worn. A perfect hedge allows a perfect dry (picture 4.19).

Follow these instructions to replace the squeegee blades:

- Lift the squeegee support up, remove the suction pipe (picture no. 12) and unloose the screws;
- Remove the squeegee from the machine and lay it on a table;
- Remove the internal and external knobs, the steel strips and the worn blades;
- Set the new blades up, tighten the knobs and regulate the squeegee.

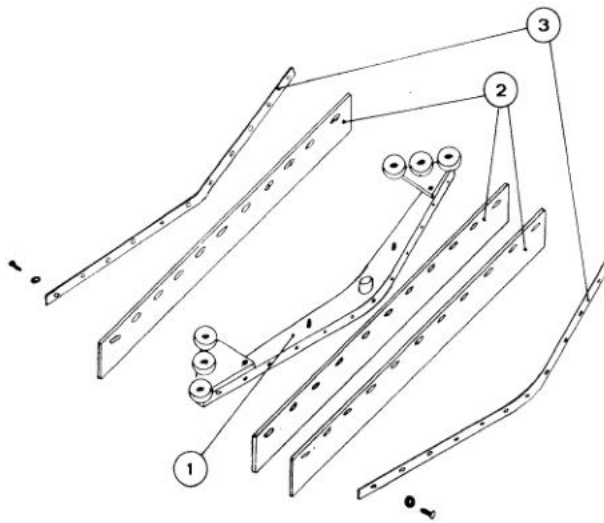

Picture no. 12

5. SAFETY

5.1. RIGHT USE OF THE MACHINE



This machine is a scrubbing machine and it has been designed and built to clean in an industrial place. It can work on flat surfaces or on sloping surfaces not higher than 12% and with a speed not higher than 2 km/h while the machine is reversing.

5.2. WRONG USE OF THE MACHINE



- *The machine cannot be driven by non-authorized personnel;*
- *The machine cannot wash sloping surfaces whose gradient is higher than 12% or surfaces with holes;*
- *The machine cannot reverse with a speed higher than 2 km/h and cannot overwhelm slopes higher than 2%;*
- *The machine cannot be used in places with dangerous substances and in particular with explosive atmospheres or with a bad microclimate;*
- *The machine cannot clean surfaces with inflammable products;*
- *The machine cannot be used as a means of transport for people or other means of transport;*
- *The protection devices of the machine cannot be modified or tampered;*
- *Batteries must be recharged in a fanned room;*
- *The operator have always to respect safety rules;*
- *The operator cannot use equipments or devices that can create problems to the machine working;*
- *The machine components cannot be modified without FIORENTINI's authorization;*
- *The operator cannot use acids that can damage the machine;*
- *The operator has always to respect the rules written in the user manual.*



Please read carefully and do not cover the labels sticked on the machine. FIORENTINI S.r.l. is not responsible for a wrong use of the machine (see § 3.2.)



Important. Use a powder extinguisher in case of fire. Do not use water.

5.3. SUGGESTED EQUIPMENT

In order to use the machine in a proper way, we suggest to use the FIORENTINI's equipment and original spare parts.

FIORENTINI S.r.l. Technical Dept. is always at your disposal to design components or parts for a particular use of machine as requested by the customer.

5.4. OPERATOR'S QUALIFY

The scheme below summarizes the operator qualify requested for each kind of operation.

OPERATION	OPERATOR'S QUALIFY
Driving/control of the machine	Trained operator
Installation/ disinstallation	Fiorentini technician
Mechanical parts maintenance	Fiorentini technician
Electric parts maintenance	Fiorentini technician
Cleaning maintenance	Trained operator
Dismantling and demolition	Fiorentini technician

FIorentINI S.r.l. suggests to train the operator before using the machine. The operator also must be trained about safety rules and carefully read this manual.



FIorentINI S.r.l. is not responsible for any possible damage to people and/or things caused by the non-observance of the instructions dealt within this manual.

5.5. SAFETY AND WARNING DEVICES

Side brushes protection	I42TD – I60TD is equipped with two rotating brushes made of nylon. The machine cannot reach dangerous areas thanks to fixed steel protections set up on each brush. These cases can be only willingly removed.
Warning devices	<p>I42TD – I60TD is equipped with several warning devices:</p> <ul style="list-style-type: none"> ➤ One acoustic warning device like a claxon. It has to warn people who are near the machine while its operating; ➤ One intermittent bleeper to warn people while the machine is reversing; ➤ One flashing yellow light to signal the machine is operating.



- ***It is absolutely forbidden to tamper or disconnect safety and warning devices while the machine is working;***
- ***It is important to check periodically safety and warning devices (see § about maintenance).***

5.6. OTHER DANGERS

FIORENTINI S.r.l. analyzes – starting from the design of the machine - all the dangers that can occur while the machine is operating in order to prevent or at least low the operator's accidents. Thanks to a series of signals on the machine the operator can avoid many risks that can occur.

SQUASHING

This kind of danger can occur:

- **During the side brushes regulation;**

Whilst regulating the side brushes, the ignition key must be kept away from the dashboard in order to avoid the casual starting of the machine.

TURNOVER

This kind of ranger can occur:

- **during the normal operating of the machine when the operator exceeds sloping limits as specified in the manual and the operator uses the machine to clean disconnected surfaces or with holes and high depressions (see 3.2)**



- **Do not use the machine to wash sloping surfaces higher than 12% or surfaces with holes or depressions which might compromise the stability of the machine.**



*FIORENTINI is not responsible for accidents occurred to people or things provoked by a wrong use of the machine, i.e. using the machine on surfaces which can compromise its stability.
The purchaser must stick proper labels on the machine to show the operator the right use of the scrubber.*

3.9. SAFETY SIGNALS

DANGERS		Dangers' signals are triangular with black pictures on a yellow background
PROHIBITIONS		Prohibitions' signals are round with black pictures and a red stripe

	What is it?	This signal forbids to remove the protection of pieces in movement.
	What to do	During the installation or the maintenance make sure that the ignition key is not in the dashboard before removing the mobile protections. While the machine is operating make sure that all covers are well fixed.



Picture no. 13

	What is it?	Squashing danger: it can be due to parts in movement of the machine.
	What to do	During the installation or the maintenance make sure that the ignition key is not in the dashboard before removing the mobile protections.



The purchaser must replace danger signals on the machine if they are deteriorated. It is absolutely forbidden to remove or temper danger signals.

**What is it?**

Explosion danger: it may occur while recharging the batteries because of hydrogen spread.

What to do

During the batteries recharge, please place the machine under a suction chimney or in a ventilated area and keep it away from heat and corrosive substances.



Picture no. 14



The purchaser must replace danger signals on the machine if they are damaged. It is absolutely forbidden to remove or temper danger signals.

	What is it?	This sticker shows fire ranger because of the presence of inflammable liquids.
	What to do	Whilst filling up the petrol tank pay attention that no primary sources are close to the machine. Use a proper funnell in order to avoid that any drops of petrol falls onto the machine.



Picture no. 15

6. STARTING THE MACHINE

6.1. TRANSPORT AND HANDLING

The machine is delivered to the purchaser in a proper package (see picture 4.1 below). A black arrow on the package shows the barycentre. This arrow must be in the middle of the elevator or transpallet forks. The package must be carefully handled. Do not place one package onto another one.



The purchaser must make sure that the machine has not been damaged during the transport and that all papers are on the machine. Otherwise, the purchaser must immediately contact FIORENTINI in order to sort out the problem.

The purchaser is responsible for the transport of the machine if not differently agreed with FIORENTINI.

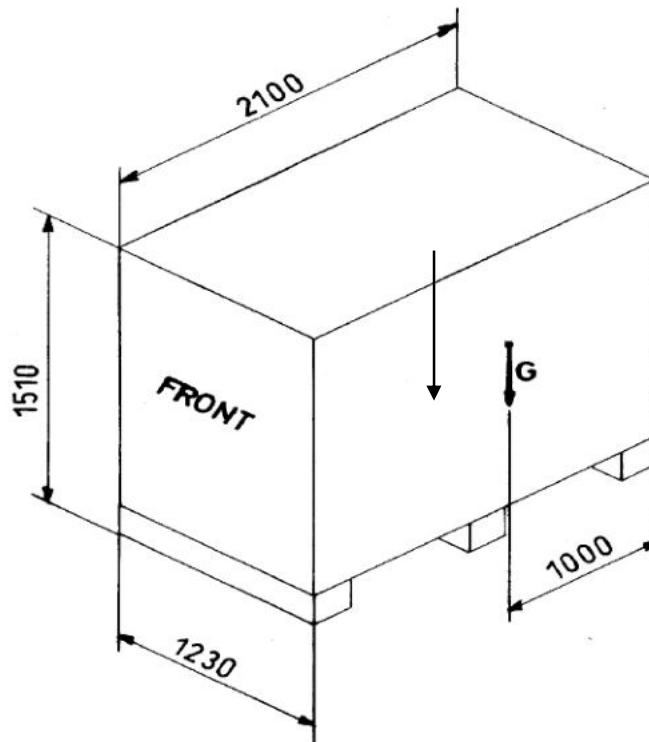

Picture no. 16

The machine must be handled with proper devices as stated in the scheme below. Please, make sure that the black arrow on the package are always in the middle of the elevator forks or the sling bands.

PACKAGE	HANDLING EQUIPMENT	PICTURE
Paperboard or plywood box on a pallet	Fork elevator	Nr. 4.2.
None	Fork elevator or crane truck with a two-band-sling and equalizer	Nr. 4.3.

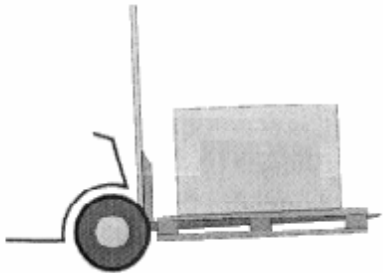
LOADING SYSTEM*Picture no. 17*

SI

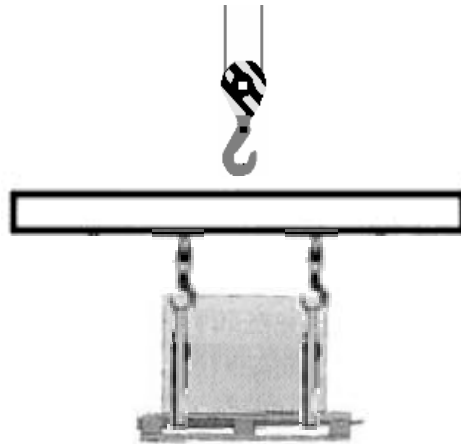
*Picture no. 18*

FIorentini suggest to use authorized personnel (see § 2.3.) to handle the machine.



The bands used for lifting the machine up must have the same loading capacity as the machine load. Handling operations must be done without causing a loss of stability of the machine. Otherwise, the machine can be damaged or the operator can be in danger.

6.2. STORAGE

The machine must be stored in a closed and dry place if it is not immediately installed in order to keep every part safe.

Relative humidity must be lower than 80% and the storage temperature must be between $3^{\circ}\text{C} \leq t \leq + 45^{\circ}\text{C}$.

6.3. STARTING THE MACHINE

The scrubber I12TD – I60TD can be started only when all components and devices of the machine have been carefully tested. This is why, well trained FIORENTINI technicians do severe tests during the machine manufacturing and a careful final test. Anyway, FIORENTINI recommends to do a second test before starting the machine. Read the scheme below:

Test	Result	
	√	X
Check the oil level of the hydraulic system	<input type="checkbox"/>	<input type="checkbox"/>
Check the engine oil level	<input type="checkbox"/>	<input type="checkbox"/>
Check the engine cooling water level	<input type="checkbox"/>	<input type="checkbox"/>
Check the functioning of the wheels brake	<input type="checkbox"/>	<input type="checkbox"/>
Check the functioning of the pilot lights	<input type="checkbox"/>	<input type="checkbox"/>

The machine can be started if the test has a positive result. Otherwise, please contact FIORENTINI Service.





The functioning test has to be periodically carried out in order to keep the machine perfect and safe.

7. MAINTENANCE

7.1. PERIODICAL MAINTENANCE

A periodical maintenance is very important in order to keep the machine in a perfect state. Please write down in the format below all the interventions done on the machine.

	If one of the machine components shows a defect, please do not use it until it will be repaired or replaced.
---	---

	Trained personnel only can service the machine and especially electric and electromechanical parts by means of suitable tools and equipments. Make reference to FIORENTINI S.r.l. only for service and spare parts (§ 7.1. and § 7.2.).
---	--

OPERATION	INTERVENTION	HOW OFTEN
Cleaning	Clean the recovery tank and the oil filter of the suction motor	Every day
	 <ul style="list-style-type: none"> • Do not use corrosive substances. • Do not use bolts of water. 	
Check up	<ul style="list-style-type: none"> ➤ Check the suction pipes and the squeegee ➤ Check the rubber suction blades of the squeegee ➤ Grease the gearing chains 	Every week
	<ul style="list-style-type: none"> ➤ Check the filter of the clean water tank ➤ Check the valve for the regulation of the washing solution 	Every month
	Check and regulate the breaking system	Every 3 months
	Check the connection of the battery cables	Every 6 months
	Check the coal brushes of each motor	
	<ul style="list-style-type: none"> ➤ Check the safety devices ➤ Check the electric system 	Every year
	➤ Top overhaul	Every 5 years

7.2. SUCTION MOTOR MAINTENANCE

The suction motor has to be checked up and cleaned. Every six months motor coal brushes have to be checked and replaced if it is necessary.

To maintain the suction motor please follow the instructions below:

- Take the ignition key off the dashboard, remove the motors cover case from the back side of the machine;
- Release the hooks (see detail 2 in picture no. 20) and disconnect the plug to remove the suction motors (see detail 1 in picture no.19);

- Remove the sponge filter under the motor, wash it and put it again in its position (see detail 3 in picture no. 19);;
- Check the motor fan through the hole in the front side of the suction motor;
- Remove the plastic cover, loosen the screws and both coal brushes supports and check the motor coal brushes (see picture no. 21);
- Do now the opposite operations to set everything up again.

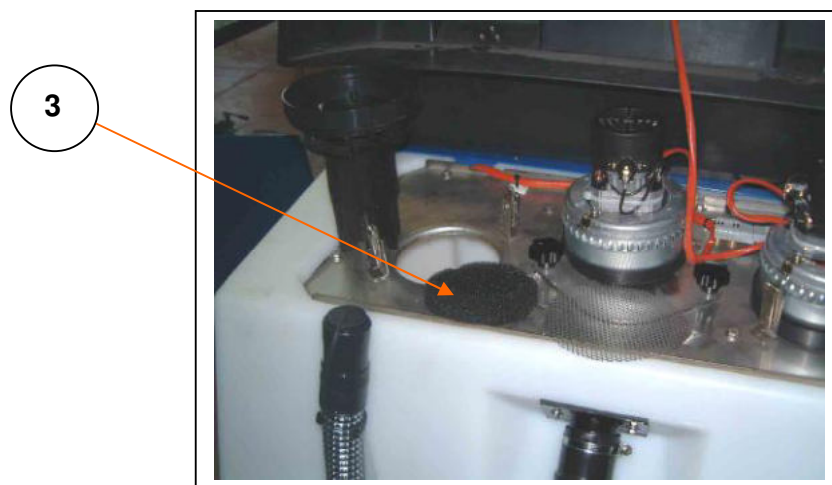
*Figura 19**Figura 20*

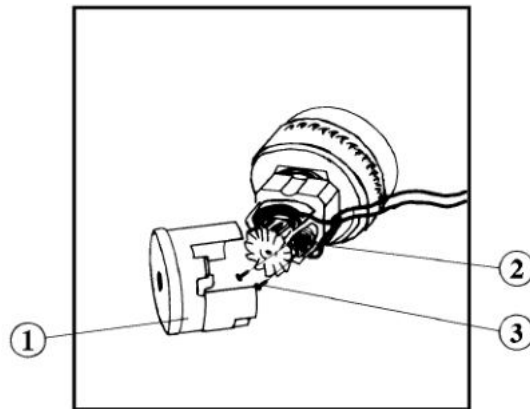

1. cap
2. coal brushes
3. coal brushes screws

Picture no. 21

7.3. DIESEL ENGINE MAINTENANCE

- Check engine oil level every 50 hours work. Oil replacement every 150 hours.
- Check the coolant every 50 hours.
- Replace the air filter every 100 hours.
- Replace the petrol filter every 250 hours.
- Replace the engine oil filter every 300 hours.
- Replace the hydraulic oil filter every 750 hours.
- Check the alternator belt tension every 250 hours.
- Clean and the injectors every 1000 hours.
- Adjust the backlash of the rocker arms every 1000 hours.



Please make reference to the diesel engine user manual for any further information the operator may need.

7.4 ELECTRIC EQUIPMENT CONTROL

It is very important to check the electric system up every two years. Disconnected cables or burnt cables must be immediately replaced.



*Interventions on the electric system must be carried out by a trained technician.
Every kind of intervention not explained in the operator manual must be carried out by FIORENTINI's technicians.*

7.5. MAINTENANCE REGISTER

<i>DATE</i>	<i>OPERATOR</i>	<i>INTERVENTION</i>	<i>SIGNATURE</i>

8. SERVICE

8.1. SERVICE ADDRESSES

Do not hesitate to contact FIORENTINI S.r.l. service for any kind of information or request.

ING. O. FIORENTINI s.r.l.

“THE BEST IN FLOOR MACHINES”

FILIALI:

20132 MILANO – Fax. 02/2592779

Via Palmanova 211/a – Tel. 02/27207783 - 2564810

00155 ROMA – Fax. 06/22754075

Via Carlo Carrà 13 – Tel. 06/22754040-2275060

STABILIMENTO:

50030 PIANCALDOLI (FI) – Fax. 055/817144

Loc. Rombola – Tel. 055/8173610

Most of the technical problems can be sorted out with short intervention. This is why FIORENTINI S.r.l. suggest to read carefully this manual before using the machine. On the contrary, if the customer needs a FIORENTINI technician, please inform us about the problem in order to sort it out with the right material.

8.2 CLAIM REPORT

Please, fill in the format below if the machine shows particular problems.

Operator:

Company: _____

Operator's name: _____

Role: _____

Date: _____

Signature: _____

Machine description:Machine: I42TD – I60TD

Type: _____

Purchase date: _____

S.N.: _____

Warranty: YES NO

Work hours: _____

Where does the machine
normally work? _____**Fault:**Code of the defected
component: _____

Description: _____

Fault:

Fault short description:

- Mechanical component
- Wrong functioning
- Electric system
- Engine
- Missing component
- Extremely noisy
- Water leak
- Other

Customer's suggestion:

Mat. n.
Serial no.
Nr. de serie

Data di spedizione
Shipment date
Date de spedition

Distributed by:

ING. O. FIORENTINI s.r.l.
"THE BEST IN FLOOR MACHINES"

FILIALI:

20132 MILANO – Fax. 02/2592779
Via Palmanova 211/a – Tel. 02/27207783 - 2564810
00155 ROMA – Fax. 06/22754075
Via Carlo Carrà 13 – Tel. 06/22754040-2275060

STABILIMENTO:

50030 PIANCALDOLI (FI) – Fax. 055/817144
Loc. Rombola – Tel. 055/8173610